

DRIVER KNOWLEDGE TEST QUESTIONS

CLASS MC (MULTI COMBINATION) LICENCE

ICAC1 - ICAC

RUH

What will happen if you are caught cheating on the knowledge test?

- You will not be allowed to take another test for 6 weeks.
- You will never be allowed to take another test.
- Nothing, there is no penalty.

ICAC2 - ICAC

RUH

What will happen if you offer a testing officer a bribe to pass your driving test?

- Action will be taken against you. The penalties are severe and include fines and imprisonment.
- Only the testing officer will be investigated.
- Nothing, there is no penalty.

ICAC3 - ICAC

RUH

What will happen if a testing officer asks you for a bribe to pass your driving test and you give it to him or her?

- Action will be taken against all involved. The penalties are severe and include fines and imprisonment.
- Nothing, there is no penalty.
- Only the testing officer will be investigated.

GENERAL KNOWLEDGE SECTION

CG009 - General Knowledge

RUH

If you breakdown on a freeway, you should -

- Move over to the emergency lane on the shoulder to the left.
- Stay where you are and wait for a tow truck.
- Move into the right-hand lane, so you can be seen.

CG030 - General Knowledge

RUH

You are driving at night with your headlights on high beam. When should you dip your headlights?

- When within 200 metres of the vehicle ahead or an oncoming one.
- When within 200 metres of an oncoming vehicle only.
- Never, you are allowed to drive with your lights on high beam at all times.

CG031 – General Knowledge

RUH

You are driving in a 60 km/h zone, with only one lane for traffic in your direction. You see a bus ahead (with this sign displayed on the rear) signalling its intention to pull out from a bus stop, you should -

- Slow down, and give way to the bus as it has priority.
- Sound your horn to stop the bus from pulling out.
- Continue at your normal speed as the bus does not have priority.



CG044 - General Knowledge

RUH

If you are involved in an accident where your vehicle needs to be towed away and the Police does not attend the crash scene, you -

- Must report the accident to the Police Station nearest to where the accident happened within 24 hours.
- Do not need to report the accident to the Police.
- Only need to report the accident to the Police if someone was injured.

CG045 - General Knowledge

If your vehicle is involved in an accident (regardless of the damage), what details must you give, to the other driver(s), if asked?

- You must let them see your licence, take details, and give the name and address of the vehicle's owner.
- No details at all until you have contacted your insurance company.
- Only your name and address details if a Policeman asks for them.



CG046 - General Knowledge

RUH

If a vehicle you are driving is involved in an accident and a person is injured, what must you do after stopping?

- Render every assistance and take immediate steps to have an ambulance notified. Then call the Police.
- Only call the Police if the accident also resulted in over \$500 worth of property damage.
- Report the accident to Police within seven days.



CG053 - General Knowledge

RUH

If you see a sign indicating road repairs are going on, you should -

- Slow down and watch for traffic controllers and instructions.
- Stop immediately and wait for instructions.
- Maintain the same speed.

CG056 - General Knowledge

RUH

If you see a horse and rider on the road what should you do?

- Slow down and give them plenty of room.
- Sound your horn to warn the rider.
- Speed up to pass the horse.

CG062 - General Knowledge

RUH

What are you required to do if you develop a serious medical condition that could affect your driving?

- Once you become aware of the condition you must notify the RTA.
- Hand your licence in at the nearest police station.
- Tell your doctor and let him or her notify the RTA.

LG002 - General Knowledge

HVH

What is the maximum allowable length of an articulated vehicle including its load?

- 19 metres.
- 25 metres.
- 10 metres.

LG004 - General Knowledge

RUH

Provided the total width of a vehicle does not exceed 2.5 metres, a load must not overhang to the sides of the vehicle by more than -

- 150 millimetres.
- 200 millimetres.
- 250 millimetres.

LG011 - General Knowledge

RUH

You are driving a vehicle with a GVM of more than 12 tonnes. Your vehicle breaks down on a road without street lights. What must you do to warn other vehicles?

- Put warning triangles at the side and between 50 and 150 metres to the front and rear of the vehicle.
- Put warning triangles 100 metres to the rear and 50 metres to the front of the vehicle only.
- Attach warning triangles to the front and rear of the vehicle.

LG012 - General Knowledge

HVH

If you are driving a truck when should you move into a lane marked by this sign?

- Only when your truck has a GVM greater than 4.5 tonnes.
- Only when your truck has a GVM greater than 13.9 tonnes.
- Only when the road is on a steep hill.



LG013 - General Knowledge

HVH

What sort of vehicles must obey this sign?

- Only vehicles with a GVM greater than 4.5 tonnes.
- Only vehicles with a GVM greater than 13.9 tonnes.
- Only articulated vehicles.



LG029 - General Knowledge

HVH

If your vehicle has air brakes how often should you drain the air tanks?

- Every day.
- Every 2 days.
- Every 7 days.

LG036 - General Knowledge

HVH

What does this sign mean?

- The gear you choose must be able to control the vehicle's speed without the use of brakes.
- The gear you choose must be able to control the vehicle's speed if you use the brakes as well.
- You must drive in first gear.



LG042 - General Knowledge

HVH

When must the rear of your heavy vehicle display the following retro-reflective marking plates?

- When your vehicle has a GVM of more than 12 tonnes.
- When your vehicle is 9 metres or longer and is over 8 tonnes GVM.
- When you drive a route bus in urban areas.

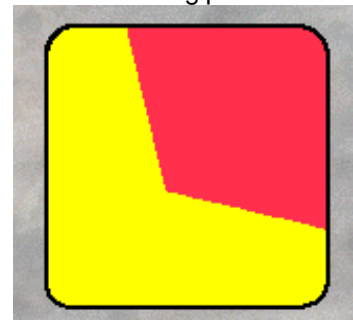

LG043 - General Knowledge

HVH

Many accidents occur when heavy vehicles are reversing. Look at the three diagrams. In which diagram is a helper (guide) best placed to guide you?

- Diagram C
- Diagram A
- Diagram B

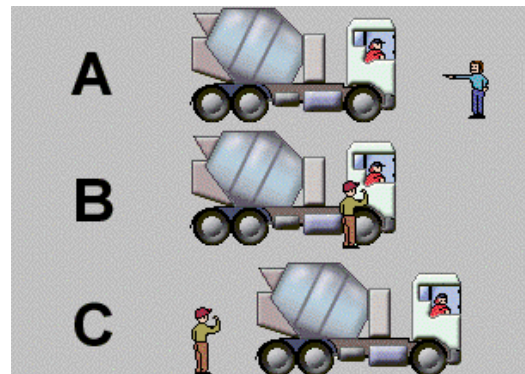

LG047 - General Knowledge

HVH

Look at the diagram. How far to the front and to the rear of the truck should you place the portable sign?

- Between 50 and 150 metres
- Between 40 and 100 metres
- Between 80 and 200 metres

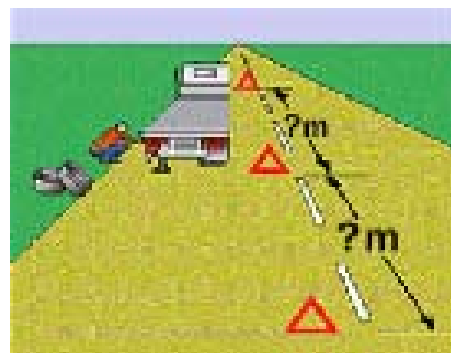

LG048 - General Knowledge

HVH

The diagram shows a portable warning triangle. The warning triangles MUST be used -

- When you break down, your vehicle weighs more than 12 tonnes laden and it is not visible for 200 metres.
- When you break down, your vehicle weighs less than 12 tonnes and you are on a road without street lights.
- When you break down regardless of the size of your vehicle.

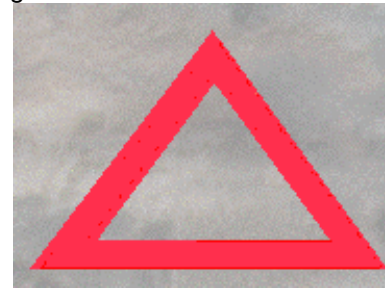

LG049 - General Knowledge

HVH

The vehicle in the diagram is over 12 tonnes GVM and has broken down on a country road. Has the driver placed the warning signs correctly?

- No.
- Yes.
- It does not matter as warning signs are not required.

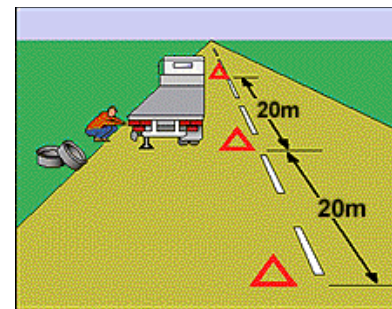

LG050 - General Knowledge

RUH

When are you required to carry your licence when driving?

- Always when driving.
- Only if driving a vehicle over 15 tonnes GVM.
- Only when driving outside of NSW.

LG054 - General Knowledge

HVH

The maximum height of all vehicles in NSW, except for double deck buses and certain types of commercial vehicles is -

- 4.3 metres.
- 4.4 metres.
- 4.6 metres.

LG055 - General Knowledge

HVH

What is the maximum width for all vehicles?

- 2.5 metres.
- 2.8 metres.
- 3.0 metres.

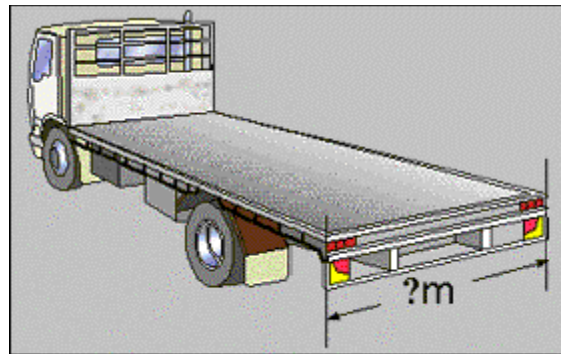

LG056 - General Knowledge

HVH

Should a driver of a truck exceeding 4.5 tonnes (Gross Vehicle Mass) always move into a lane marked with this sign?

- Yes, at all times until a sign indicates the end of the lane.
- No, only when traffic is too heavy in the normal driving lanes.
- No, only when the road descends steeply ahead.



LG057 - General Knowledge

HVH

Work time in your heavy vehicle work diary includes -

- Any time you spend on tasks related to the operation of a regulated heavy vehicle.
- Driving time only.
- Driving, cleaning and refueling only.

LG058 - General Knowledge

HVH

Can I borrow someone else's work diary to record my work and rest hours?

- No, the work diary is your personal record.
- Yes, the work diary belongs to the regulated heavy vehicle and any driver can use it.
- Yes, but only if you are in a two-up arrangement.

LG059 - General Knowledge

HVH

In the heavy vehicle work diary, the driver base is -

- The place from where the driver normally does the work.
- The driver's home address.
- The nearest RTA motor registry.

LG060 - General Knowledge

HVH

Fatigue law applies to drivers of all heavy vehicles or truck and trailer combinations -

- over 12 tonnes or a bus that seats more than 12 adults.

- over 4.5 tonnes or a bus that seats 5 adults including the driver.
- over 8 tonnes or a bus that seats 10 adults including the driver.

LG061 - General Knowledge
What is a regulated heavy vehicle?

HVH

- All heavy vehicles with a GVM over 12 tonnes or truck and trailer combinations with a GVM over 12 tonnes or a bus that seats more than 12 adults.
- All heavy vehicles with Federal Interstate registration.
- All heavy vehicles over 4.5 tonnes.

LG062 - General Knowledge
In your heavy vehicle work diary, what is rest time -

HVH

- Rest time is time that is not counted as work.
- Rest time is only when you are sleeping.
- Rest time is only when you are at home.

LG063 - General Knowledge
In your heavy vehicle work diary, how do you count rest time -

HVH

- Rest time is counted in blocks of 15 minutes.
- Rest time is counted in blocks of 10 minutes.
- Rest time is counted in hourly blocks.

LG064 - General Knowledge
When should I sign, date and add up the work and rest hours in my heavy vehicle work diary?

HVH

- Every day on the daily sheet in the work diary.
- Once a week in the work diary.
- Once a month in the work diary.

LG065 - General Knowledge

HVH

This sign is displayed on the approach to a bridge or tunnel. You should -

- Only proceed if your loaded vehicle is less than the maximum legal height of 4.3 metres.
- Only proceed if your loaded vehicle is less than 4.4 metres wide.
- Only proceed if you think your loaded vehicle can pass through.

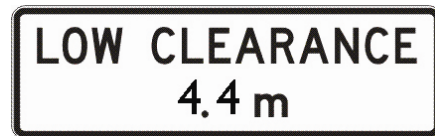

RG002 - General Knowledge

HVH

What is the maximum allowable width of a B-Double?

- 2.5 metres.
- 1.5 metres.
- 3.5 metres.

RG003 - General Knowledge

HVH

What sign must be displayed to the rear of a B-Double?

- LONG VEHICLE.
- B-DOUBLE.
- ROAD TRAIN.

RG005 - General Knowledge

PO

Where must a 'ROAD TRAIN' sign be displayed on a road train combination?

- At the front of the hauling unit and to the rear of the last trailer in the combination.
- At the front of the hauling unit only.
- On each unit of the combination.

RG008 - General Knowledge

PO

Can a 'Road Train' sign be displayed on vehicles that are not coupled together as a road train?

- No
- Yes
- Yes if they travel less than 80 Km from the vehicle's usual depot

RG009 - General Knowledge

PO

Must all units in a road train combination be registered?

- Yes.
- No, only the hauling unit.
- Yes, only if operating outside the approved area.

RG013 - General Knowledge

HVH

Which of the following is true when you are coupling a vehicle and trailer?

- Your prime mover and semi-trailer should be in a straight line.
- Your prime mover and semi-trailer should be at a 90 degree angle.
- You should never use your hand brake.

RG014 - General Knowledge

HVH

A B-Double is -

- An articulated vehicle with a second semi-trailer attached to the rear of the first semi-trailer by means of a turntable.
- A truck hauling two or more trailers.
- An articulated vehicle with a second semi-trailer attached to the rear of the first semi-trailer by means of a draw bar.

RG015 - General Knowledge

HVH

A Road train is -

- A truck hauling two or more trailers or a prime mover and semi-trailer hauling one or more trailers.
- A large vehicle capable of hauling two semi-trailers.
- A prime mover and semi-trailer hauling one or more trailers one of which must be a dog trailer.

RG017 - General Knowledge

HVH

A road train is a truck hauling how many trailers?

- Two or more.
- One only.
- Two only.

RG018 - General Knowledge

HVH

What sign must be fitted to the back of a B-double?

- Long vehicle.
- Wide vehicle.
- Over-dimensional vehicle.

RG020 - General Knowledge

HVH

Vehicle monitoring device records for B-Doubles must be retained for at least how long?

- 6 months.
- 1 month.
- 3 months.

ROAD SAFETY SECTION

AD004 - Alcohol and Drugs

RUH

To reduce the effect of alcohol before driving or riding you should -

- Wait. The time depends on how much you have drunk.
- Drink black coffee.
- Have a glass of water.

AD009 - Alcohol and Drugs

RUH

Before driving a motor vehicle or riding a motor cycle it is safest -

- Not to drink any alcohol.
- Drink 1 nip of spirits (30 ml or 1 oz).
- Drink 1 midy (285 ml) of light (low alcohol) beer.

AD012 - Alcohol and Drugs

RUH

Is it an offence to refuse to take a POLICE breath test?

- Yes - always.
- No - if you say you haven't been drinking alcohol.
- No - if you are a learner driver.

AD013 - Alcohol and Drugs

RUH

If you take medicine and then drink alcohol -

- It can have a particularly bad effect on your driving ability.
- The alcohol will have less effect than if taken alone.
- Your ability to react to emergencies will improve.

AD014 - Alcohol and Drugs

RUH

If you are driving a bus, taxi, hire-car, heavy motor vehicle (over 13.9 tonnes Gross Vehicle Mass), or a vehicle with a dangerous load, it is an offence when the level of alcohol in your blood reaches -

- 0.02.
- 0.05.
- 0.08.

AD015 - Alcohol and Drugs

RUH

Having 1 or 2 alcoholic drinks before driving -

- Will affect your reactions and judgement.
- Improves your driving ability.
- Has no effect on your driving ability.

AD016 - Alcohol and Drugs

RUH

Even if you feel unaffected after drinking alcohol, you should -

- Be aware that your abilities are decreased.
- Drive, but avoid using freeways.
- Spend more time than usual looking in the mirrors.

AD020 - Alcohol and Drugs

HVH

You are driving a commercial bus (coach) or a heavy truck with a GVM of more than 13.9 tonnes. You are offered an alcoholic drink during lunch. You refuse because your blood alcohol limit has to be -

- Under .02.
- Under .05.
- Zero.

AD021 - Alcohol and Drugs

HVH

Drivers of public passenger vehicles must stay below what blood alcohol (BAC) level?

- .02.
- Zero.
- .05.

AD024 - Alcohol and Drugs

HVH

You are driving a vehicle which carries dangerous load. You are offered an alcoholic drink during lunch. You refuse because your blood alcohol limit has to be -

- Below .02.
- Below .05.
- Zero.

AD025 - Alcohol and Drugs
Alcohol is a depressant. This means -

RUH

- It slows down how quickly your brain works.
- It speeds your brain up so you can work better.
- It makes you calm down and think more clearly.

AD026 - Alcohol and Drugs
After drinking alcohol you could -

RUH

- Misjudge speed (your own and others).
- Be able to drive the same as you normally can.
- Be able to pay close attention to details in the traffic.

AD033 - Alcohol and Drugs
When drivers have been drinking, the crashes they are involved in are generally -

RUH

- More serious.
- Less serious.
- About the same.

DR001 - Alcohol and Drugs RUH
If you are taking any sort of medicine, you should -

- Find out from your doctor or chemist whether the medicine or drug will affect your driving and act accordingly.
- Only drive during the day after taking the medicine or drug.
- Only drive a motor car not a heavy vehicle.

DR002 - Alcohol and Drugs RUH
Before taking any drugs and then driving it is most important to -

- Know what the effects of the drug are.
- Plan to have some other person with you.
- Have some food in your stomach.

DR004 - Alcohol and Drugs RUH
If you have used illegal drugs you -

- Must not drive.
- May drive only in light traffic.
- Should drink coffee before driving.

DR005 - Alcohol and Drugs HVH
You are not sure if a new medicine will affect your driving. What should you do?

- Ask your doctor or pharmacist.
- Only drive with a passenger.
- Do not drive at night.

DR006 - Alcohol and Drugs HVH
Is it correct that drugs such as cold and flu pills, codeine and sedatives can combine to affect your ability to drive safely?

- Yes.
- Yes, but only if you drink alcohol when taking them.
- No.

DR007 - Alcohol and Drugs

HVH

What is a drug?

- Any chemical substance which alters the normal way that your brain or body works.
- Only medicines prescribed by a doctor or pharmacist.
- Only illegal substances not prescribed by your doctor.

DR008 - Alcohol and Drugs

HVH

A heavy vehicle driver has taken some medication for a head cold. Could this affect the person's driving?

- Yes.
- No.
- Only if the driver drinks alcohol while taking the medication.

DR009 - Alcohol and Drugs

RUH

If you are affected by a legal drug, such as a medicine (e.g. cold or allergy tablets) -

- You must not drive.
- You must have a passenger to help you drive.
- You may drive only in daylight hours.

FD001 - Fatigue and Defensive Driving RUH
Under good conditions, when driving behind any vehicle, at any speed, you should -

- Stay at least three seconds behind the vehicle in front of you.
- Drive as close to the vehicle in front as possible.
- Stay one second behind the vehicle in front of you.

FD002 - Fatigue and Defensive Driving RUH
When driving in wet weather, your vehicle will -

- Take longer and further to stop, so slow down.
- Stop in the same distance as on a dry road.
- Handle better, so you can go faster.

FD003 - Fatigue and Defensive Driving RUH
At night, if an oncoming vehicle's headlights dazzle you, you should -

- Slow down, until your eyes recover.
- Watch the centre line of the road.
- Close your eyes for a short time until they recover.

FD004 - Fatigue and Defensive Driving RUH3
If you get sleepy while driving, out of the following, which is it best to do?

- Stop, rest, and change drivers if possible.
- Turn on the radio very loud.
- Turn on the heater.

FD005 - Fatigue and Defensive Driving RUH
In wet weather when it becomes hard for you to see, you should -

- Turn on your headlights, slow down, and double your following distance behind the vehicle in front.
- Turn your headlights on high beam.
- Flash your headlights to warn other drivers.

FD006 - Fatigue and Defensive Driving RUH
If you are driving and it starts to rain, you should -

- Slow down using the brake gently, since rain and oil may create a slippery surface.
- Put your lights on high beam so you can see better.
- Put your hazard warning lights on and increase your speed to avoid the rain.

FD007 - Fatigue and Defensive Driving RUH
When driving on a slippery wet road, for example, one covered in early morning dew, your vehicle will -

- Take longer and further to stop.
- Be heavier to steer.
- Be easier to steer and handle.

FD010 - Fatigue and Defensive Driving RUH
Why should you avoid heavy braking on a wet road?

- Your wheels may skid and cause a loss of control.
- If the wheels lock up your handbrake may not work.
- You might wet pedestrians walking along the footpath.

FD011 - Fatigue and Defensive Driving RUH
At night you should -

- Leave a longer gap behind the vehicle in front.
- Use your hazard warning lights when overtaking another vehicle.
- Drive closer to the vehicle in front so they can see you better.

FD013 - Fatigue and Defensive Driving RUH
When going on a long trip, out of the following which is the most important to do?

- Get plenty of rest before starting out.
- Make sure your horn is working.
- Have a good meal before driving.

FD014 - Fatigue and Defensive Driving

RUH

At night, when you approach an oncoming vehicle, you should -

- Not look at its headlights, but keep left and watch the left of the road.
- Carefully watch the vehicle by looking directly at its headlights.
- Put your lights on high beam, to make your vehicle more easily seen.

FD023 - Fatigue and Defensive Driving

HVH

Driver fatigue can be prevented by which of the following -

- Taking a break from driving every few hours.
- Opening the cabin vents fully.
- Drinking at least one litre of strong coffee every two hours.

FD024 - Fatigue and Defensive Driving

HVH

Most crashes caused by fatigue occur between what hours?

- 11pm and 8am.
- 9am and 9pm.
- 8pm and midnight.

FD025 - Fatigue and Defensive Driving

HVH

The only effective way to deal with driver fatigue is to -

- Prevent it by being well rested and taking regular breaks.
- Drink plenty of strong, black coffee.
- Eat foods high in fat before driving.

HVDH

FD042 - Fatigue and Defensive Driving

In addition to your work and rest hours what must you include in your work diary?

- Your location and odometer reading at each work and rest change.
- Your average speed.
- Your total distance travelled each week.

HVDH

FD043 - Fatigue and Defensive Driving

If you are working under Standard Hours and drive a vehicle with a GVM greater than 12 tonnes, in a period of 8 hours what is the minimum rest time?

- 30 minutes rest, in blocks of 15 minutes.
- 60 minutes rest, in blocks of 15 minutes.
- 15 continuous minutes rest.

HVDH

FD044 - Fatigue and Defensive Driving

If you are a solo driver working under Standard Hours and drive a vehicle with a GVM greater than 12 tonnes, what is the maximum number of hours you may drive in any seven day period?

- 72 hours.
- 60 hours.
- 80 hours.

FD045 - Fatigue and Defensive Driving HVDH
How many days of work diary driving records must you keep in your vehicle?

- 28 days.
- 14 days.
- 7 days.

FD046 - Fatigue and Defensive Driving HVDH
If you are a solo driver working under Basic Fatigue Management hours and drive a vehicle with a GVM greater than 12 tonnes, in a period of 9 hours what is the minimum rest time?

- 30 minutes rest, in blocks of 15 minutes.
- 60 minutes rest, in blocks of 15 minutes.
- 15 continuous minutes rest.

FD047 - Fatigue and Defensive Driving HVDH
If you are working under Standard Fatigue Management Hours, what is the maximum number of hours you are allowed to work in any 24 hour period?

- 12 hours.
- 14 hours.
- 7 hours.

FD048 - Fatigue and Defensive Driving HVDH
If you are working under Standard Fatigue management Hours, in a two-up arrangement what is the maximum number of hours you are allowed to work in any 24 hours period?

- 12 hours.
- 14 hours
- 13 hours.

FD049 - Fatigue and Defensive Driving HVDH
If you are working under Standard Fatigue Management Hours, in a two-up arrangement, what is the maximum number of hours you are allowed to work in any 7 day period?

- 60 hours.
- 72 hours.
- 36 hours.

IN001 - Intersections

RUH

As you approach an intersection, you should check for traffic on your left and right -

- At all times before entering the intersection.
- Only when the traffic is heavy.
- Only when you approach a stop sign.

IN002 - Intersections

RUH

There are no traffic signs or signals at an intersection. If you intend to drive through the intersection, you must give way to -

- Vehicles on your right.
- Vehicles on your left only.
- An oncoming vehicle about to turn right.

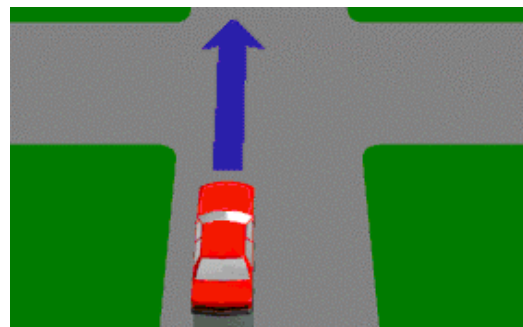

IN003 - Intersections

RUH

When making a right-hand turn at the intersection shown, you must give way to -

- An oncoming vehicle going straight ahead or turning left, and any vehicle on your right.
- A vehicle approaching from your left and intending to turn right.
- Only pedestrians.

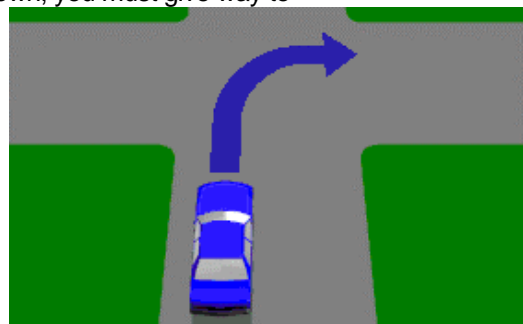

IN004 - Intersections

RUH

If turning right at a T-intersection (as shown) must you give way to vehicles approaching from both the left and right?

- Yes, whether they are turning or not.
- No, only the vehicle on the right.
- No, you have right of way.

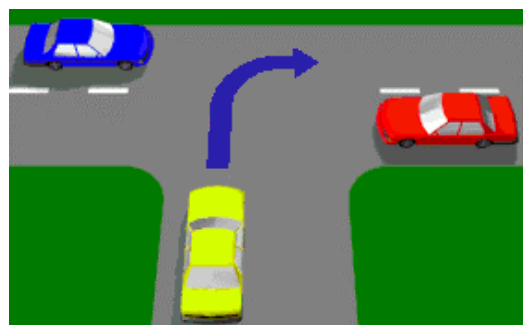

IN005 - Intersections

RUH

If a STOP or GIVE WAY sign has been knocked down, for example, as the result of an accident, does the line marked across the road have any meaning?

- Yes, it has the same meaning as the sign itself.
- No, but you must give way if turning.
- No, you only need to give way to the vehicle on your right.

IN006 - Intersections

RUH

If turning at an intersection are you required to give way to pedestrians?

- Yes, a driver turning right or left must give way to pedestrians, if there is a danger of a collision
- Yes, only if turning left.
- Yes, only if turning right.

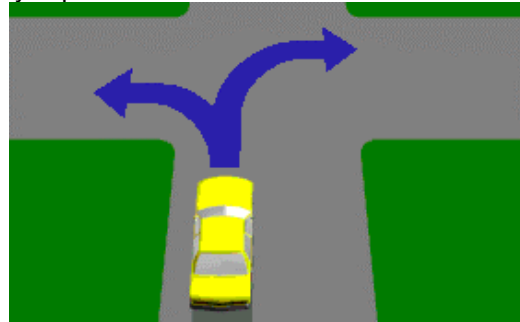

IN007 - Intersections

RUH

When you come to an intersection and the road beyond is choked with vehicles going in the same direction, what should you do?

- Wait until there is room for you to completely cross the intersection.
- Proceed if there is no traffic on your right.
- Travel into the intersection and wait until traffic ahead moves.

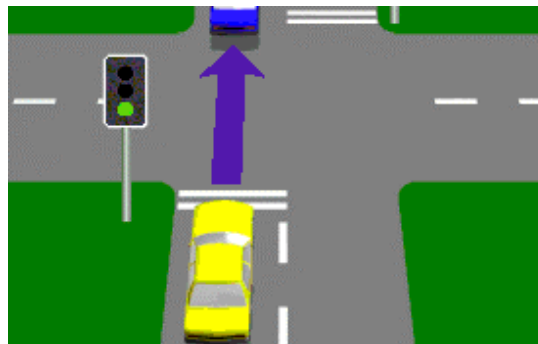

IN008 - Intersections

RUH

Right-turns must be made from which lanes when travelling on a laned roadway?

- The far right-hand lane or any other lane having an arrow pointing right.
- The lane carrying the least amount of traffic.
- The far left-hand lane.

IN010 - Intersections

RUH

In this diagram both vehicles O and P must pass through GIVE WAY signs before entering the intersection -

- Vehicle P goes first.
- Vehicle O goes first.
- It depends on who moves first.



IN011 - Intersections

RUH

Vehicle O is at a STOP sign -

- Vehicle O must give way to vehicles P, Q and R.
- Vehicle O must give way only to vehicle R.
- All vehicles must give way to vehicle O.

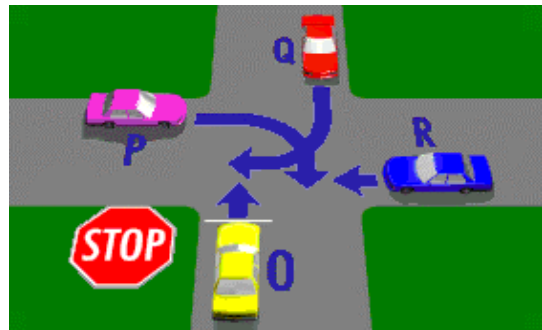

IN012 - Intersections

RUH

If both vehicles P and O in the diagram are turning right, which vehicle is in the best position to turn left into the street marked 'X'?

- Vehicle O.
- Vehicle P.
- Neither vehicle.

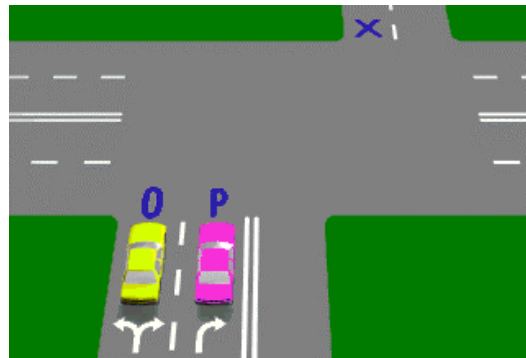

IN013 - Intersections

RUH

The diagram shows a marked pedestrian crossing at an intersection. There is also a STOP sign at the intersection. You have already stopped for a pedestrian. Must you stop again at the STOP line?

- Yes, at all times.
- Yes, if there is traffic on your right only.
- No, if the intersection is clear.

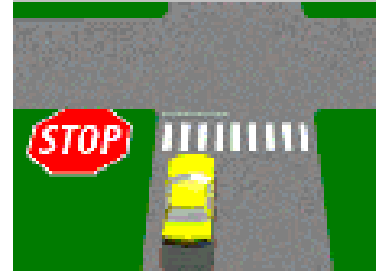

IN014 - Intersections

RUH

A GIVE WAY sign at an intersection means that you must -

- Be ready to stop and give way to all other traffic if there is danger of a collision.
- Stop completely at all times and have no right of way.
- Slow down and only give way to traffic on your right.

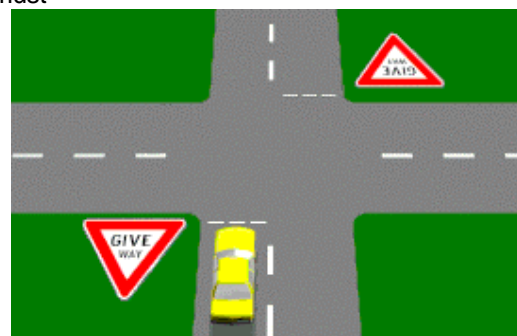

IN016 - Intersections

RUH

Which vehicle in the diagram must give way?

- Vehicle J.
- Vehicle K.
- Vehicle L.

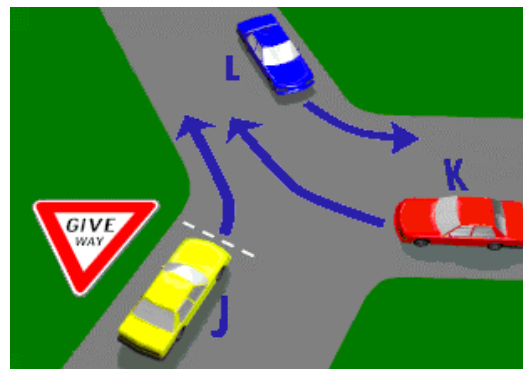

IN018 - Intersections

RUH

You want to make a left turn. You must use your left-hand indicator -

- At all times.
- Only when there is traffic behind you.
- Only when arrows are marked on the roadway.

IN019 - Intersections

RUH

At the T-intersection shown in the diagram which vehicle should give way?

- Vehicle R.
- Vehicle Q.
- Whichever vehicle got there last.

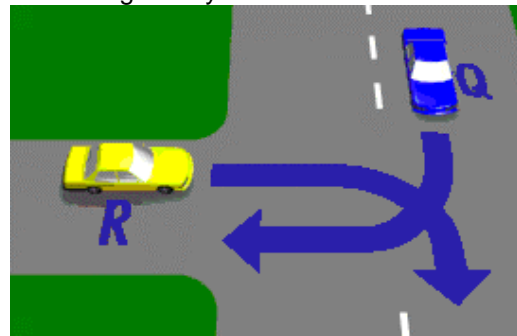

IN026 - Intersections

RUH

What should you do on approaching a railway level crossing displaying a STOP sign?

- Stop at all times and proceed when safe to do so.
- Slow down to 10 km/h, then proceed through the crossing.
- Stop, only if a train is at the crossing.



IN027 - Intersections

RUH

You are driving the car in the diagram. You must stop -

- Even when there is no other traffic.
- Only if there is a car on your right or left.
- Only if there is danger of a collision with another vehicle.

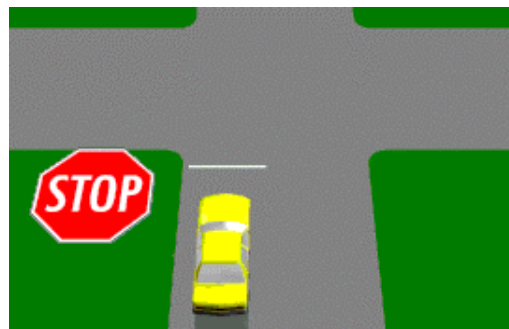

IN028 - Intersections

RUH

If the boomgates are down and the signals are flashing, at a railway level crossing, you may begin to cross -

- Only when the gate is up and the lights stop flashing.
- If you cannot see a train approaching.
- If you can safely go around the closed gate.

IN029 - Intersections

RUH

When approaching a railway level crossing displaying this sign, you must -

- Slow down, look both ways for trains and be prepared to stop if necessary.
- Increase your speed to avoid any approaching trains.
- Continue across at normal speed, do not slow down.



IN030 - Intersections

RUH

Even if the signal at a railway level crossing does not indicate that a train is coming, you should -

- Slow down, be ready to stop and give way if there is danger of collision.
- Speed up and cross the tracks quickly.
- Stop completely at all times.

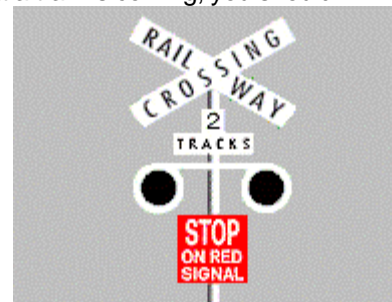

IN031 - Intersections

RUH

You are in the car approaching the intersection shown, you should -

- Drive carefully and approach at a speed which gives you good time to avoid traffic which might suddenly appear.
- Come to a complete stop before you come to the intersection.
- Flash your lights to let other vehicles know that you are coming.

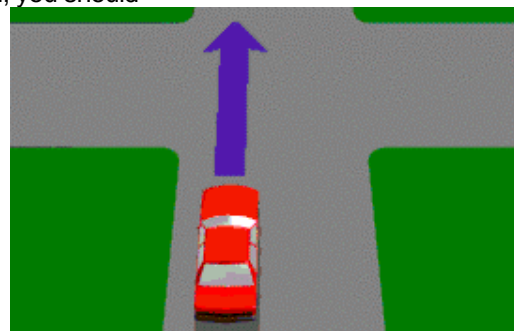

LD001 - Traffic Lights / Lanes

RUH

How should you merge with traffic when entering a freeway?

- Watch for a gap and merge with the traffic at the speed it is travelling.
- Speed up and force your way into the traffic.
- Stop, then enter the traffic quickly.

LD002 - Traffic Lights / Lanes

RUH

Which movements shown in the diagram can legally be made by the driver of the purple car?

- O and P only.
- P only.
- O, P and Q.

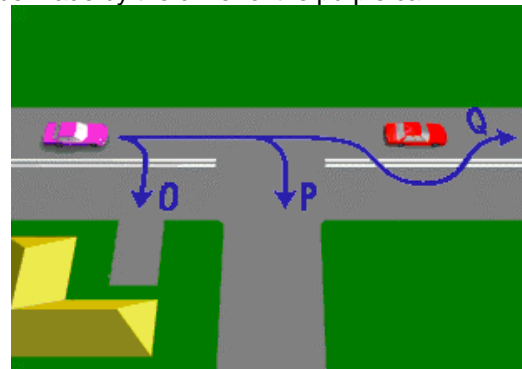

LD003 - Traffic Lights / Lanes

RUH

Which movements shown in the diagram can legally be made by the driver of the purple car?

- O, P and Q.
- O and P only.
- P only.

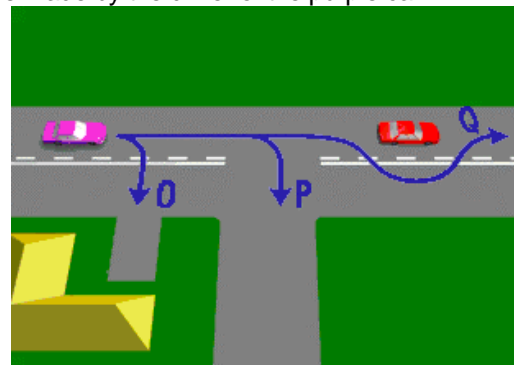

LD004 - Traffic Lights / Lanes

RUH

Which movements shown in the diagram can legally be made by the driver of the purple car?

- O and P only.
- P only.
- O, P and Q.

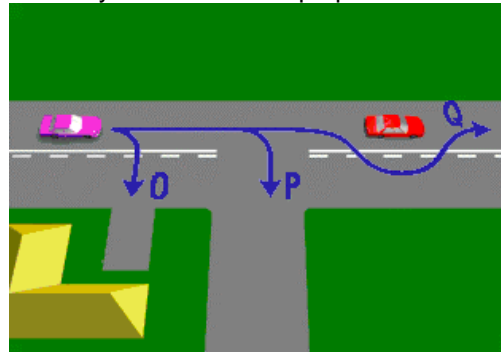

LD005 - Traffic Lights / Lanes

RUH

Double unbroken dividing lines are marked on a roadway. You may -

- Cross them to turn into a driveway or property, if it is safe to do so.
- Cross them to overtake a car ahead if it is safe to do so.
- Cross them to make a U-turn.

LD006 - Traffic Lights / Lanes

RUH

You are on an open country road with double unbroken dividing lines. There are no side streets and no entrances to properties. Are you allowed to cross the dividing lines?

- No, not under any circumstances.
- Yes, to overtake another vehicle.
- Yes, to overtake a pedal cyclist.

LD007 - Traffic Lights / Lanes

RUH

A section of road is marked with double unbroken dividing lines as in the diagram. When is a vehicle allowed to cross these lines?

- To enter or leave a street or driveway.
- To overtake a slow vehicle ahead.
- When there is no traffic coming the other way.

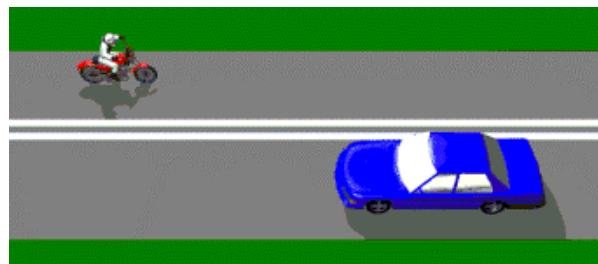

LD009 - Traffic Lights / Lanes

RUH

When driving in traffic lanes (as shown in the diagram), you may change your lane -

- Only when it is safe to do so.
- Without looking, provided you use your indicator
- Provided you sound your horn to warn other drivers

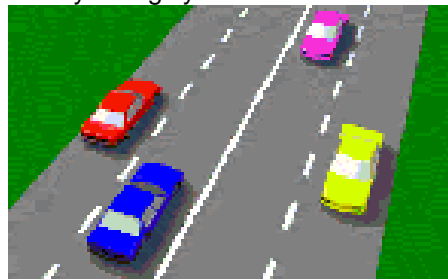

LD010 - Traffic Lights / Lanes

RUH

When two lanes merge into one (as shown in the diagram), who should give way?

- The vehicle which has to cross the lane line.
- The faster vehicle.
- The vehicle in the right-hand lane because it is overtaking.

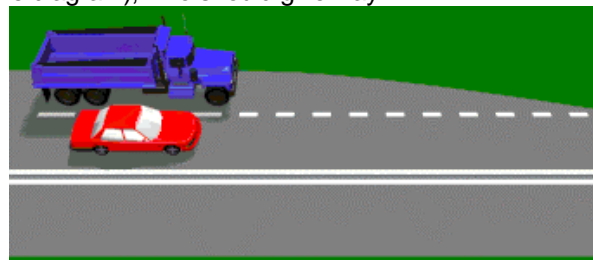

LD011 - Traffic Lights / Lanes

RUH

Looking at the diagram, which vehicle must give way?

- Vehicle B.
- Vehicle A.
- Either vehicle, there is no rule on giving way when merging.

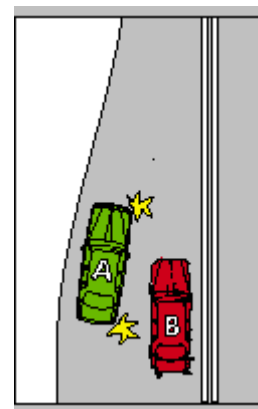

LD013 - Traffic Lights / Lanes

RUH

You must use your indicator lights when -

- Changing lanes at any time.
- There is a right-hand bend in the road.
- Driving across a railway level crossing.

LD014 - Traffic Lights / Lanes

RUH

If you hear the siren of an emergency vehicle, you must -

- Take whatever action is necessary (with safety) to make way for the emergency vehicle.
- Flash your headlights to warn other drivers.
- Increase your speed to avoid the vehicle.

LD041 - Traffic Lights / Lanes

RUH

When driving on a multi-lane road with a speed limit of more than 80 km/h, which lane should you choose?

- The left lane unless overtaking.
- The right lane to avoid slow moving vehicles.
- Either left or right lane.

LD043 - Traffic Lights / Lanes

RUH

Signalling is -

- Always required before turning or lane changing.
- Not required when turning at T-intersections.
- Not required when turning at traffic lights with a green arrow.

LR001 – Load Restraint

HVH

What is the maximum allowable distance that a load may project on the side of a vehicle, provided overall width does not exceed 2.5 metres?

- 150mm
- 200mm.
- 250mm.

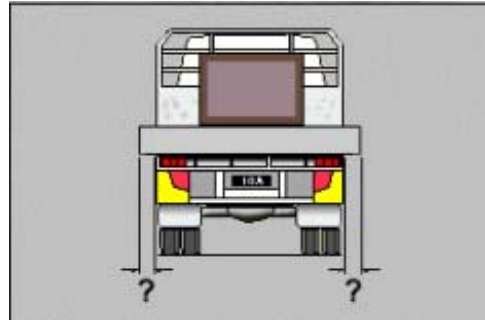

LR002 - Load Restraint

HVH

What is the maximum length that a load may project in front of a vehicle?

- 1.2 metres.
- 0.8 metres.
- 2.0 metres.

LR003 - Load Restraint

HVH

The most important part of blocking when securing a load is -

- The headboard or bulkhead.
- The chocks.
- The outriggers.

LR004 - Load Restraint

HVH

In which diagram is the load NOT blocked?

- Truck 2.
- Truck 3.
- Truck 1.

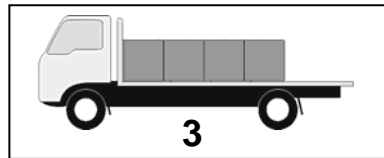
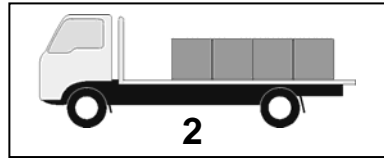
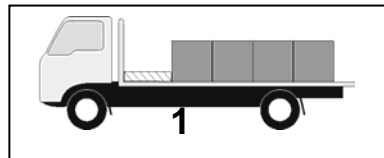

LR005 - Load Restraint

HVH

A poorly loaded vehicle is unsafe to drive. To avoid loss of steering and loss of traction under power, you should -

- Spread the load close to the centre line of the vehicle.
- Load heavy items to one side.
- Stack the lighter things at the bottom.

LR009 - Load Restraint

LRG/ HVH

The truck shown in the diagram below is braking heavily. In what direction will the unrestrained load on the truck tray move?

- Forwards.
- Backwards.
- Sideways.

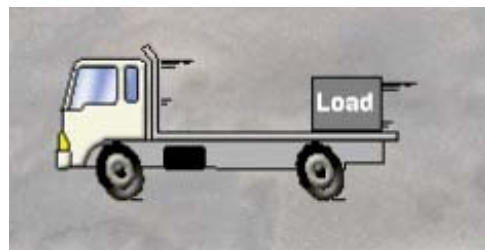

LR010 - Load Restraint

LRG/ HVH

The load on the vehicle shown in the diagram below is resting against the headboard. This method of load restraint is known as -

- Blocking.
- Attaching.
- Containing.

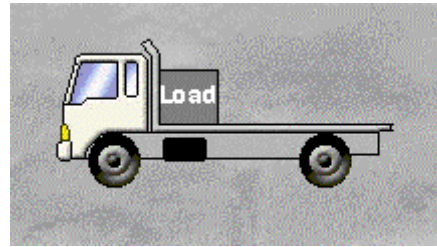

LR011 – Load Restraint

LRG

A load restraint system on a vehicle should be capable of restraining what percentage of the weight of the load from shifting forwards and upwards?

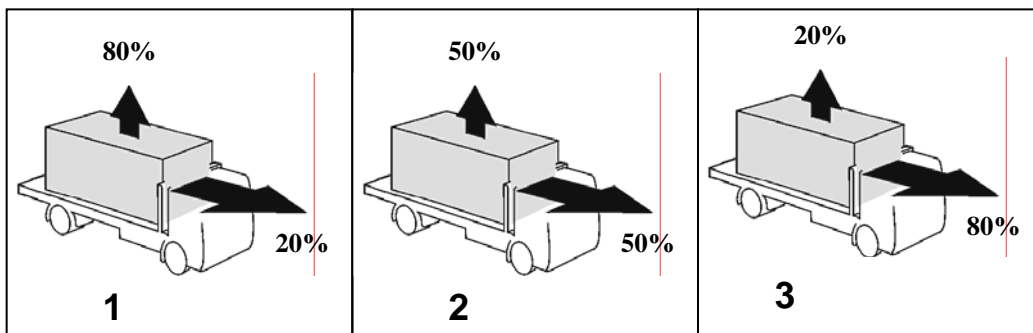

- Diagram 3
- Diagram 2
- Diagram 1

LR012 – Load Restraint

LRG

A load restraint system on a vehicle should be capable of restraining what percentage of the weight of the load from shifting sideways or rearwards?

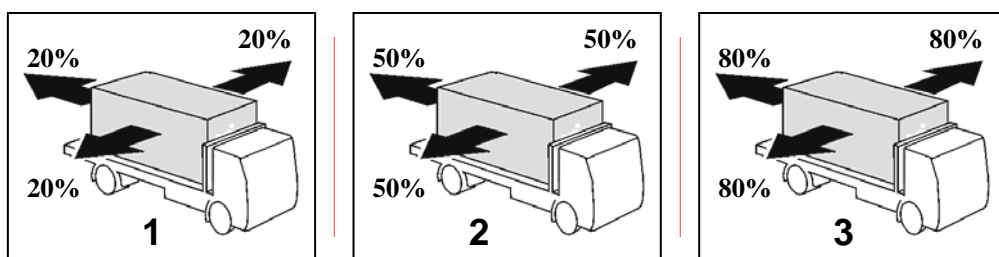

- Diagram2
- Diagram 1
- Diagram 3

LR013 – Load Restraint

LRG

Which 'tie down angle' is not recommended for lashings?

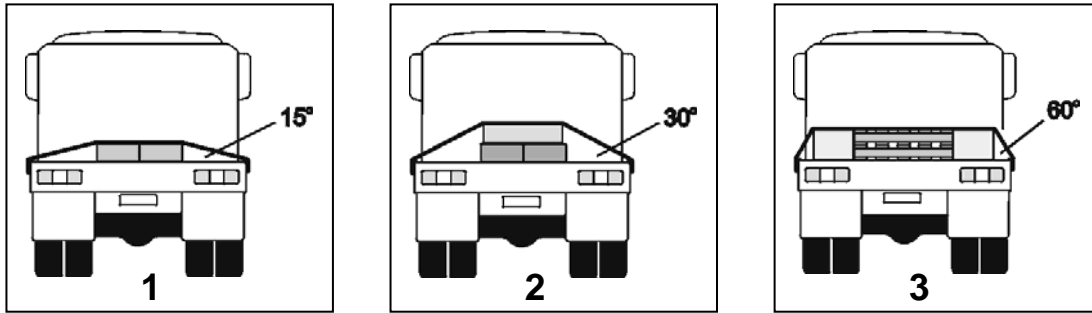

- Truck 1

- Truck 2

- Truck 3

LR014 – Load Restraint

HVH/LRG

Vehicles carrying what type of loads are more likely to overturn on corners?

- **High centre of mass loads and 'live'; (eg. Bulk liquids, livestock) loads**

- Blocked loads.

- Heavy loads.

LR015 - Load Restraint

LRG/HVH

When loading cardboard cartons and boxes on a vehicle, where should the heaviest items be placed?

- At the bottom of the load.

- At the top of the load.

- Distributed evenly throughout the stack of cartons or boxes.

LR016 – Load Restraint

LRG

The vehicle shown in the diagram below are loaded with logs. Which ones have correctly secured loads?

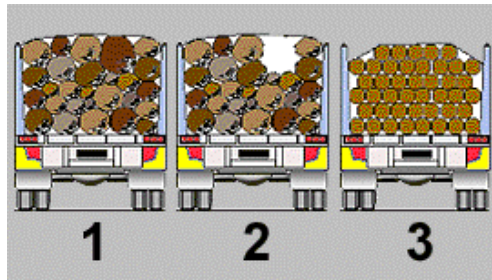

- **Vehicles 1 and 3.**
- Vehicles 1 and 2.
- Vehicle 3 only.

LR018 - Load Restraint

HVH

For vehicles with a GVM over 4.5 tonnes (excluding cranes) the vehicle width, including the load, must not be greater than -

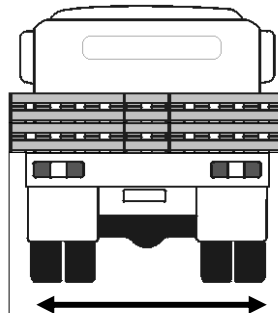

- **2.5 metres**
- 3.2 metres
- 1.2 metres

LR020 – Load Restraint

HVH

Sheets and tarpaulins are not strong enough to hold down bulk loads unless the load is -

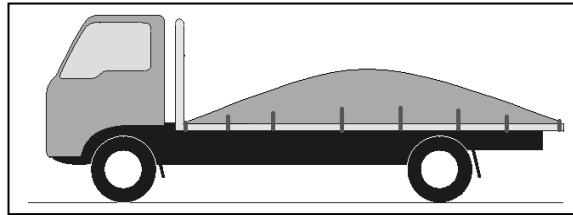

- **Very light.**
- Very wet.
- Very heavy.

LR021 – Load Restraint

HVH

Which of the diagrams shows the correct loading position to prevent twisting of the chassis frame?

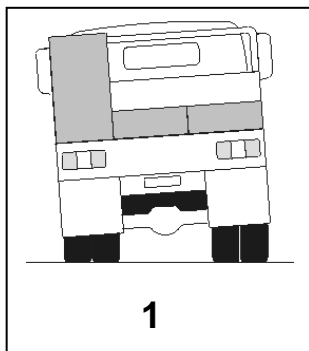

1

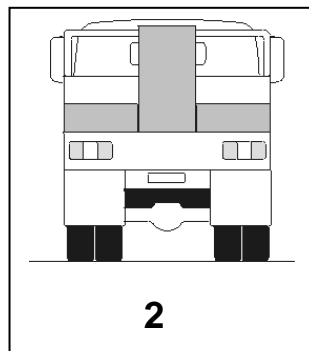

2

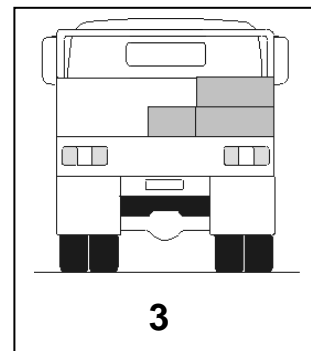

3

- **Diagram 2**
- Diagram 3
- Diagram 1

LR022 – Load Restraint

LRG

Which diagram shows the correct method for restraining a loose load?

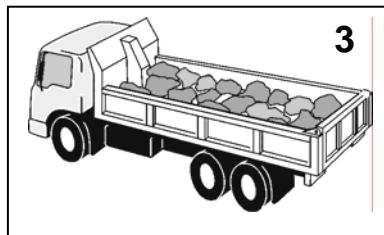
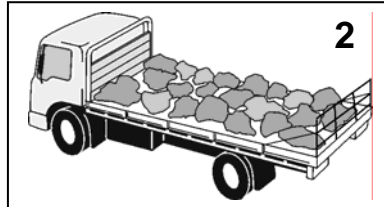
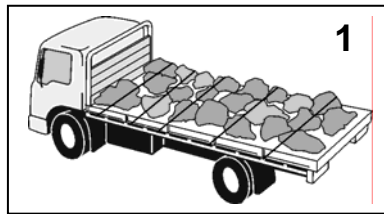

- **Diagram 3**
- Diagram 2
- Diagram 1

LR023 – Load Restraint

LRG

Which diagram shows the correct load position to ensure weight on the steer axles?

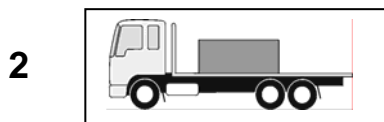
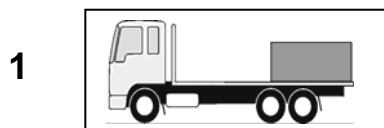

- **Diagram 2**
- Diagram 3
- Diagram 1

LR024 – Load Restraint

HVH

Which diagram shows the correct dunnage position for long rigid loads such as steel pipes?

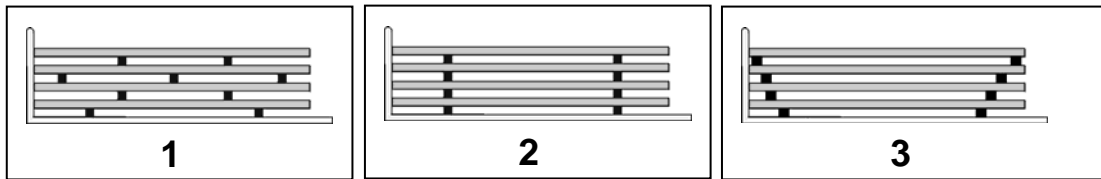

- **Diagram 2**
- Diagram 3
- Diagram 1

LR025 – Load Restraint

LRG

Which of the following methods will best directly restrain a contained load?

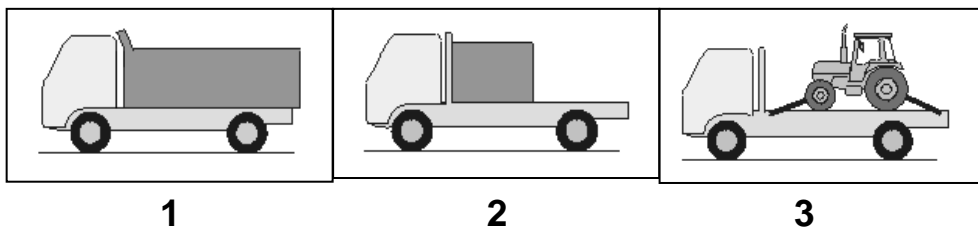

- **Diagram 1 - Tankers, tipper bodies.**
- Diagram 2 - Headboards, side / tail gates.
- Diagram 3 - Direct lashings.

LR027 – Load Restraint

LRG

Which diagram shows the correct method for restraining small pipe or log loads?

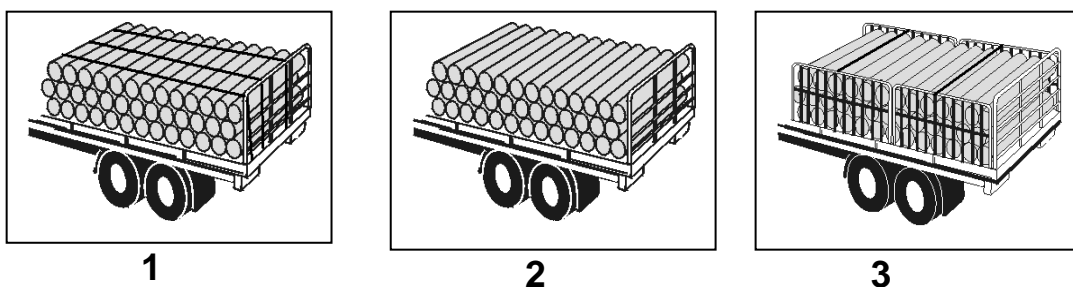

- **Diagram 3**
- Diagram 2
- Diagram 1

LR028 – Load Restraint

LRG

Which diagram shows the correct method for restraining large pipe loads?

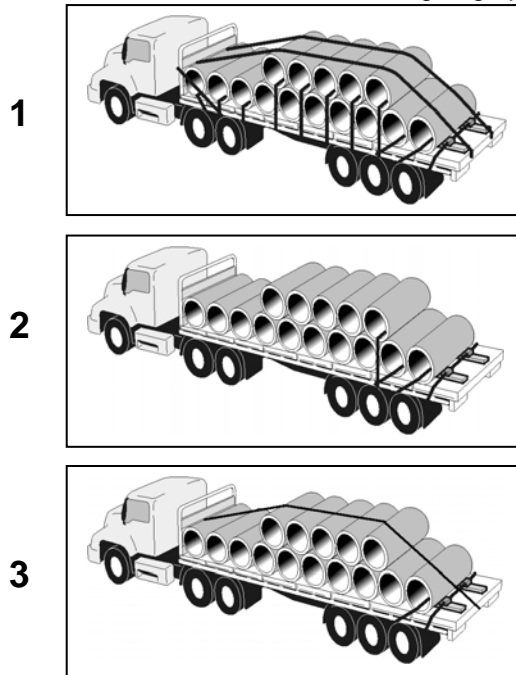

- **Diagram 1**
- Diagram 2
- Diagram 3

LR029 – Load Restraint

LRG

Which diagram shows the correct method for restraining divided loads?

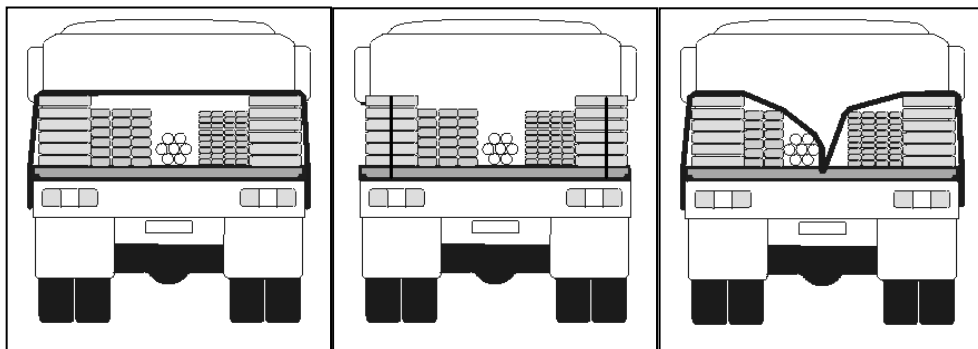

1

2

3

- **Diagram 3**
- Diagram 2
- Diagram 1

LR030 – Load Restraint

HVH

Which diagram shows the correct position for carrying loads with potentially dangerous projections?

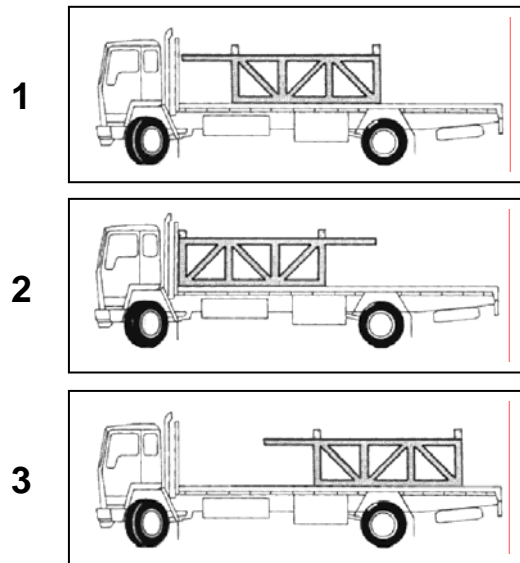

- **Diagram 2**
- Diagram 3
- Diagram 1

LR031 – Load Restraint

HVH

Which diagram shows the best method for securing loads and protecting lashings?

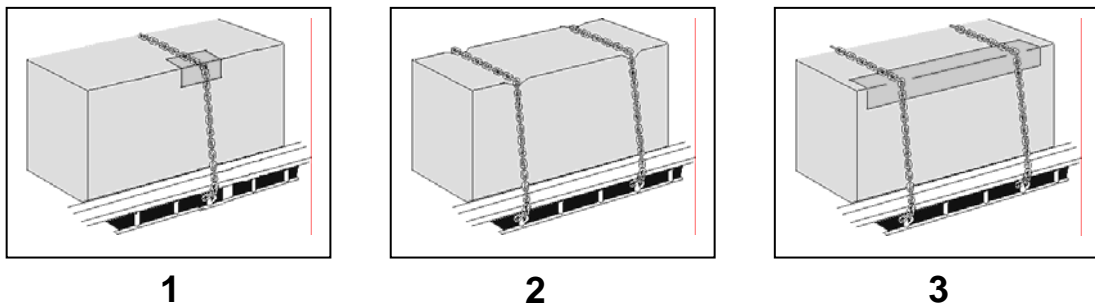

- **Diagram 3**
- Diagram 2
- Diagram 1

LR032 – Load Restraint

HVH/LRG

Loaded shipping containers fitted with corner twist locks should -

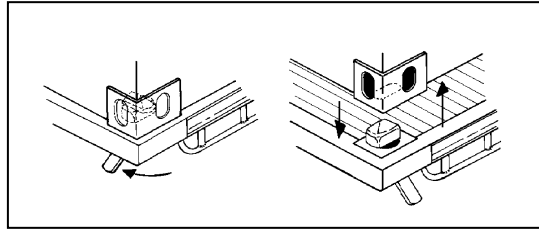

- **Not be carried on trucks not fitted with twist locks.**
- Be chained to a truck that is not fitted with twist locks.
- Only be carried on trucks if secured with webbing.

ND002 - Negligent Driving

RUH

When driving near parked vehicles, you should -

- Check for parked vehicles with turn signals on, or children about to step out.
- Stop, if you see a car with its right-hand indicator on.
- Sound your horn and flash your headlights to warn drivers not to pull out.

ND004 - Negligent Driving

RUH

You are approaching a hill or curve. You must not cross the centre line if you cannot see clear road ahead for -

- 150 metres.
- 100 metres.
- 75 metres.

ND005 - Negligent Driving

RUH

You are approaching the crest (top of a hill) on a narrow road, the safest procedure is to -

- Keep to the left and slow down.
- Flash your headlights to warn oncoming traffic.
- Increase your speed and sound your horn.

ND007 - Negligent Driving

RUH

On a single laned road (as shown), you must always overtake another vehicle on its right except when -

- The other vehicle is turning right.
- You are travelling at more than 80 km/h.
- The other vehicle is going slower than you.

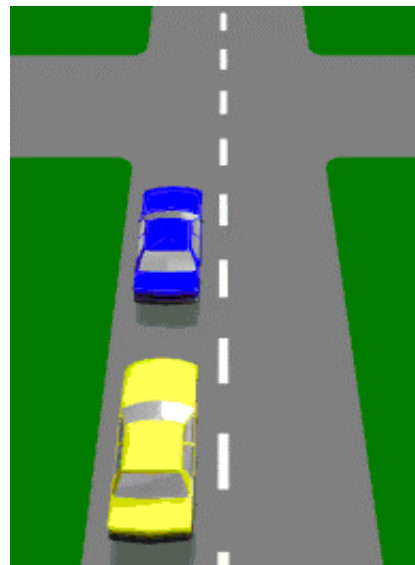

ND008 - Negligent Driving RUH
When overtaking another vehicle you should NOT move back in front of it, unless –

- You can see the overtaken vehicle in your rear vision mirror.
- An oncoming car appears over a hill.
- The driver of the vehicle signals it is safe to do so.

ND009 - Negligent Driving RUH
A driver behind you signals their intention to overtake your car. What should you do?

- Keep to the left and let that driver overtake you.
- Speed up so that the driver will not have to overtake.
- Signal the driver to remain behind you if it is travelling too fast.

ND010 - Negligent Driving RUH
The faster the vehicle in front of you is travelling, the -

- More distance and time you need to overtake.
- Less time you need to overtake.
- Closer you must get before starting to overtake.

RUH

ND011 - Negligent Driving
If you are not sure you have enough distance to overtake a vehicle ahead, you should -

- Wait for a better opportunity with more distance to overtake.
- Put the vehicle in a lower gear and speed up.
- Sound your horn to signal the driver ahead to slow down.

ND012 - Negligent Driving RUH
When being overtaken by another vehicle what should you do to help?

- Keep left and allow plenty of room to let the other vehicle back in.
- Brake quickly to let the other vehicle overtake.
- Move to the left and stop.

ND013 - Negligent Driving

RUH

You are in the purple vehicle, you may overtake the vehicle in front -

- Only on its right-hand side.
- On either side.
- Not at anytime.

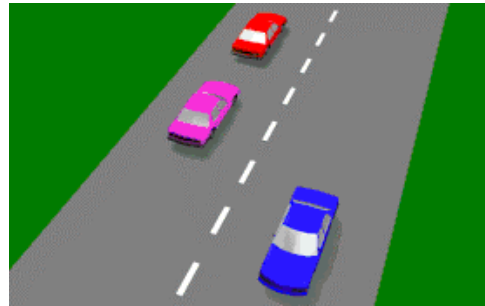

ND014 - Negligent Driving

RUH

Before beginning to overtake another vehicle, you should -

- Check to see it is safe, change gear if necessary, and signal your intention before moving out.
- Signal and slow down so you will have more room to overtake.
- Sound your horn, move out and overtake.

ND015 - Negligent Driving

RUH

You are driving behind a long vehicle (as shown) which has a sign saying DO NOT OVERTAKE TURNING VEHICLE. The long vehicle indicates that it is going to turn left. You -

- Must let the long vehicle turn first.
- May move to the left-hand side of the road and pass the long vehicle.
- May pass the truck because it cannot turn left from the middle lane.



ND019 - Negligent Driving

RUH

How should you overtake a pedal cyclist?

- The same as you would another car, with safety.
- Drive as close as possible to the cyclist so he or she will move over and let you pass.
- Sound your horn to warn the cyclist to get off the road.



ND020 - Negligent Driving

RUH

If an overtaking vehicle signals that it must move in, in front of you, you should -

- Prepare to slow down to allow room.
- Speed up and not let the vehicle back in.
- Flash your lights at the overtaking vehicle.



ND021 - Negligent Driving

RUH

The first thing you should do before overtaking is -

- Make sure it is safe and the way is clear of oncoming traffic.
- Sound your horn.
- Increase your speed.

ND035 - Negligent Driving

RUH

Another vehicle is overtaking you on your right. You commit a traffic offence if you -

- Speed up while the other vehicle is on your right.
- Keep the same speed.
- Slow down while the other vehicle is on your right.

PD001 - Pedestrians

RUH

You must give way to pedestrians on a marked pedestrian crossing -

- If there is any danger of a collision.
- When they are crossing from your right only.
- When they are crossing from your left only.

PD002 - Pedestrians

RUH

When approaching a marked pedestrian crossing and no pedestrians are in sight, you should -

- Slow down and be ready to make a safe stop.
- Come to a complete stop before the crossing.
- Go faster, in case a pedestrian steps onto the crossing.



PD003 - Pedestrians

RUH

If elderly people or children are on a pedestrian crossing you will probably need to –

- Wait extra time to allow them to cross safely.
- Sound your horn to hurry them up.
- Drive around them so you don't hold up traffic.

PD004 - Pedestrians

RUH

Which sign painted on the road tells you there is a pedestrian crossing ahead?

- B
- A
- C

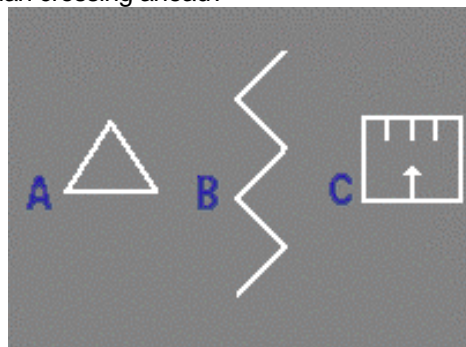

PD005 - Pedestrians

RUH

A vehicle ahead of you has stopped at a pedestrian crossing. You -

- Must not overtake the stopped vehicle.
- May overtake the vehicle if there are no pedestrians on the crossing.
- May overtake the vehicle provided no cars are coming the other way.

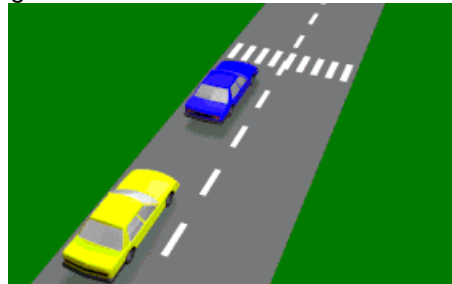

PD006 - Pedestrians

RUH

If you see a School Crossing Supervisor holding a sign like this, you must wait until the children -

- Are off the crossing and the hand held sign is taken away.
- Reach the right-hand side of the crossing.
- Are out of sight.

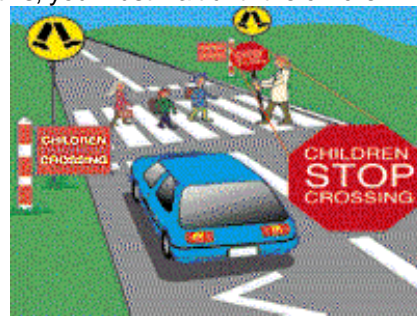

PD007 - Pedestrians

RUH

Which one of the following statements is correct? Bicycle riders -

- Must obey the road rules.
- May not travel on heavy traffic roads.
- Must ride against the flow of traffic so they can be seen.

PD009 - Pedestrians

RUH

When driving near children, playing or walking near the edge of the road, you should -

- Slow down, and be ready to make a safe stop.
- Blow your horn and continue at the same speed.
- Drive close to the children so they will see you.

PD010 - Pedestrians

RUH

Pedestrians who are affected by alcohol, are -

- One of the most common groups involved in road accidents.
- Unlikely to walk near the road and do not require your attention.
- Less dangerous than sober pedestrians because they are more careful after drinking.

PD011 - Pedestrians

RUH

When driving near pedestrian crossings, intersections, or school crossings, you should always -

- Slow down, watch for pedestrians and be ready to make a safe stop.
- Move into the left lane.
- Keep your eyes on the speedo.

PD012 - Pedestrians

RUH4

When driving in an area where there are many pedestrians (e.g. a bus stop) it is important to -

- Slow down and watch for an indication that they will enter the road.
- Put your headlights on high beam so they can see you better.
- Increase your speed to avoid the chance of hitting them.

PD013 - Pedestrians

RUH

When driving past parked vehicles, which of the following is it most important to do –

- Watch for pedestrians, animals and car doors opening.
- Drive in the right-hand lane, if there is one.
- Stay as close as possible to the vehicle in front of you.

PD014 - Pedestrians

RUH

When driving in wet weather, you should -

- Watch out for pedestrians, who may hurry and take risks.
- Drive in the middle of the road to avoid splashing pedestrians on the footpath.
- Stop and help aged pedestrians across the road.

PD015 - Pedestrians

RUH

At a pedestrian crossing with traffic lights, when the amber light starts 'flashing' after the red stop signal, it means -

- You may carefully drive through the crossing, if there is no risk of colliding with pedestrians.
- The traffic lights are out of order and pedestrians must not use the crossing.
- The green light is due. Do not proceed until the green light appears.

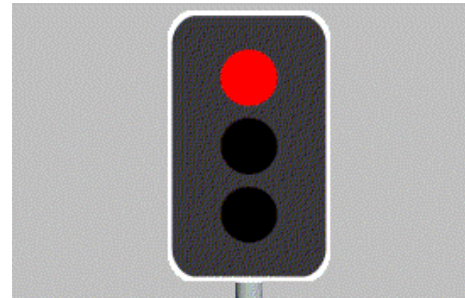

PD016 - Pedestrians

RUH

Which statement is true?

- You must give way to pedestrians if there is any danger of hitting them.
- Pedestrians have no special rights on the roads.
- You must give way to pedestrians only at marked crossings.



PD017 - Pedestrians

RUH

You drive towards these people on the road. What should you do?

- Stop and give way if there is any danger of hitting them.
- Continue at the same speed and sound the horn.
- Slow down until they are half way through the crossing and drive on.

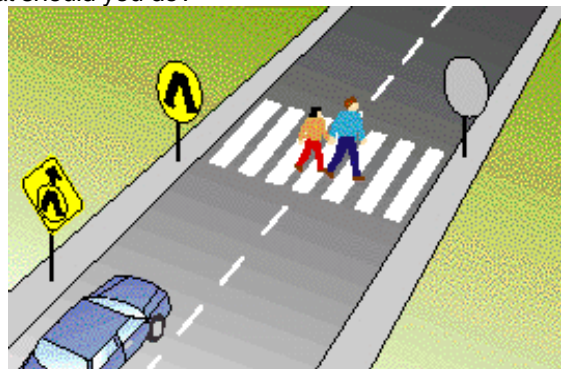

PD018 - Pedestrians

RUH

You see these zig-zag markings on the road in front of you. What do they mean?

- Take care and look out for pedestrians at a crossing.
- Look out for animals on the side of the road.
- Be careful because the road ahead is slippery.



PD019 - Pedestrians

RUH

These markings on the road indicate -

- Places where pedestrians have special rights.
- Places where you can park.
- Places where special speed limits apply.

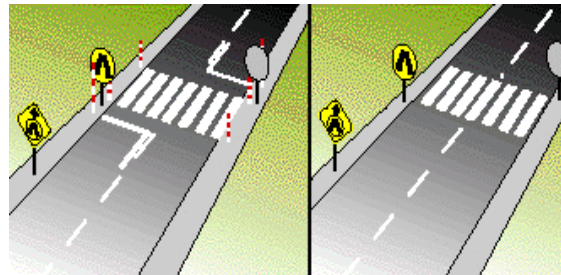

PD021 - Pedestrians

RUH

You approach a person crossing the road. You should -

- Slow down or stop to avoid hitting the person.
- Slow down and sound your horn to hurry up the person.
- Maintain your speed and swerve around the person.

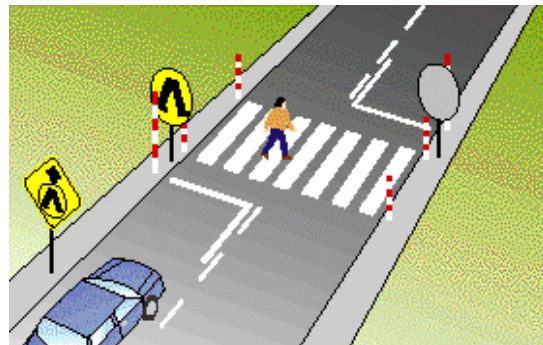

PD022 – Pedestrians

RUH

You approach a crossing and see the scene in the picture. You should -

- Slow down and stop until the supervisor takes down the sign.
- Slow down and drive through giving way to the children.
- Stop and wait for the children until your lane is clear.



PD023 - Pedestrians

RUH

At a pedestrian crossing with traffic lights, when the lights change to red you should -

- Stop, wait for pedestrians to cross and for the green light to come on.
- Slow down and give way to pedestrians.
- Stop and continue after the pedestrians have crossed.

PD024 - Pedestrians

RUH

This person is standing on a pedestrian refuge. If he steps out onto your lane you should -

- Give way to the person if there is any danger of colliding.
- Slow down and sound the horn to warn the person to move back.
- Maintain your speed so you do not hold up the traffic.



PD025 - Pedestrians

RUH

Which of the following statements is correct?

- You must give way to pedestrians if there is a danger of a collision.
- Pedestrians must cross the road only at marked crossings and intersections.
- You do not have to give way to adults crossing at children's crossings.



PD026 - Pedestrians

RUH

When you see children on or near the road -

- You should slow down and be more careful because they may move suddenly.
- You should reduce your speed by 5 km/h.
- You should ignore them and pay attention to the rear vision mirror.



PD027 - Pedestrians

RUH

When you see older people on or near the road, you should -

- Slow down and take extra care because they may not see you until you are very close.
- Drive around them to keep the traffic moving.
- Sound your horn and keep going at the same speed so you do not hold up the traffic.



PD028 - Pedestrians

RUH

You must give way to pedestrians if there is a risk of hitting them. When driving in poor light, you should -

- Look more carefully for pedestrians because they are hard to see.
- Keep your headlights on high beam all the time.
- Always drive in the right hand lane so you can be away from pedestrians.

PD030 - Pedestrians

RUH

You drive up to a Light Rail vehicle that has just stopped at a tram stop. What is the most important thing you should do?

- Take extra care, slow down and give way to the pedestrians.
- Keep a look out for traffic coming in the opposite direction.
- Slow down, but keep moving so you do not delay other drivers.



SB004 - Seat Belts / Restraints RUH
A child over 12 months, must -

- Use a seat belt or child seat.
- Not travel in a motor vehicle.
- Sit in the front seat of the vehicle.

SB007 - Seat Belts / Restraints RUH
The most effective device for protecting passengers when in an accident is –

- Seat belts.
- Safety door latches.
- Padded instrument panels.

SB008 - Seat Belts / Restraints RUH
Which one of the following statements is correct? Seat belts -

- Save lives and prevent injury.
- Do not have to be used in the rear seat.
- Are not necessary for good drivers.

SB009 - Seat Belts / Restraints RUH
If there is a 2 year old child in the car while you are driving and the child is not wearing a seat belt, who is responsible?

- The driver.
- The child.
- The parent of the child.

SB011 - Seat Belts / Restraints RUH
Seat belts and child restraints (eg baby capsules and child seats) -

- Must always be worn properly, and adjusted tightly.
- Are only needed on long trips.
- Are only needed on short trips.

SB012 - Seat Belts / Restraints

RUH

Child restraints (eg, baby capsules and child seats) -

- Should be fitted according to the manufacturers' instructions.
- Are not as safe as holding a child in your arms.
- Need only be used if the child wants to sleep.

SL007 - Speed Limits

RUH

Driving faster than the maximum speed limit is -

- Never legally permitted.
- Permitted only when passing another vehicle.
- Only permitted when other vehicles are going faster than the speed limit.

SL008 - Speed Limits

What is your maximum speed limit if you are driving a vehicle with a GVM over 4.5 tonnes

- 100 km/h.
- 90 km/h.
- 110 km/h.

SL011 - Speed Limits

HVH

You drive a vehicle (not a road train) with a GVM of more than 4.5 tonnes. The maximum speed limit that you are permitted to travel at is -

- 100 km/h.
- 90 km/h.
- 110 km/h.

SL012 - Speed Limits

RUH

One in three fatal crashes in NSW is speed related. What is the speed limit where there are no speed limit signs and no street lights?

- 100 km/h.
- 40 km/h.
- 60 km/h.

SL014 - Speed Limits

HVH

Look at the diagram. This means that -

- Trucks and buses MUST travel at a speed not greater than 40 Km/h.
- Trucks and buses may travel at a speed of 40 Km/h.
- Trucks and buses MUST travel at a speed not less than 40 Km/h.



SL016 - Speed Limits

HVH

A speed limiter fitted to a heavy vehicle in NSW (other than a road train) prevents that vehicle from exceeding what speed limit?

- 100 Km/h.
- 90 Km/h.
- 105 Km/h.

SL018 - Speed Limits

HVH

Speed limiters for road trains are required to be set for what maximum speed capability?

- 90 Km/h.
- 100 Km/h.
- 110 Km/h.

SL019 - Speed Limits

HVH

The sign shown in the diagram below is -

- A regulatory sign for truck and bus drivers which must be obeyed.
- An advisory sign for truck and bus drivers that should be obeyed.
- A regulatory sign for drivers of vehicles greater than 30 tonnes GVM.



SL020 - Speed Limits

PO

A B-Double must be speed limited so that it has a maximum road speed capability of -

- 100 Km/h.
- 90 Km/h/
- 110 Km/h.

SL025 - Speed Limits

RUH

What could be the penalties for driving over the speed limit -

- Fines, demerit points and possibly loss of licence.
- Fines only.
- A letter of warning and a small fine.

SL028 - Speed Limits

RUH

Where there are no speed limit signs, the speed limit is 100 km/h, unless -

- There are street lights along the road.
- The road you are driving on is gravel.
- There's an emergency, which mean speed limits don't apply.

SL035 - Speed Limits

RUH

If you are driving along the highway and come across road works with a reduced speed zone, you must -

- **Slow down to the new speed limit.**
- Drive through the road works zone as fast as you can to get past it.
- Drive at the same speed as other vehicles.

TL001 - Traffic Lights / Lanes

RUH

You are facing traffic lights (as shown). What do they mean?

- You may proceed only in the direction of the green arrow.
- You may proceed only in the direction of the green arrow when the red light has changed to green.
- You must give way to oncoming traffic.

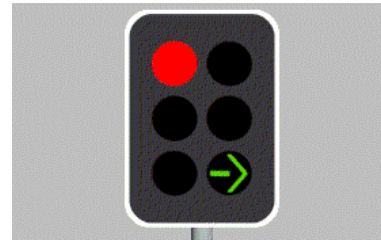

TL002 - Traffic Lights / Lanes

RUH

At traffic lights what is meant when a red light appears?

- Stop, wait behind the stop line until the lights change to green.
- Stop, wait behind the stop line until the lights change to yellow.
- Stop, make sure there is no traffic, then drive straight ahead.

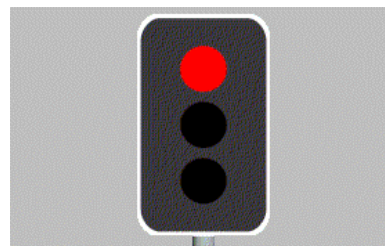

TL003 - Traffic Lights / Lanes

RUH

What should you do when approaching traffic lights which change from green to yellow?

- Stop at the stop line unless you are so close that sudden or sharp braking might cause an accident.
- Speed up to clear the intersection before the lights change to red.
- Stop, only if a red light camera is in use.

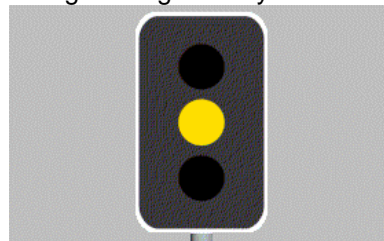

TL004 - Traffic Lights / Lanes

RUH

What may you do at an intersection with traffic lights at which this sign is displayed?

- If the lights are red you must first stop, then you may turn left if it is safe to do so.
- You should slow down and check if anyone is coming before turning left.
- You may turn left only if a green arrow is shown.

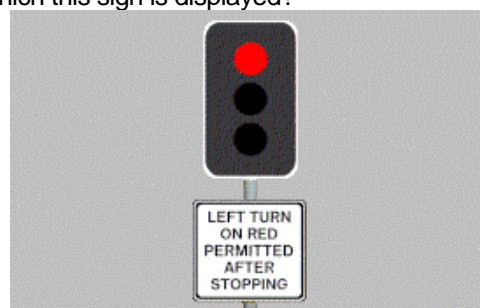

TL008 - Traffic Lights / Lanes

RUH

It is 3 o'clock in the morning. You cannot see any other traffic. You want to turn right. You may -

- Not turn right while the arrow is red.
- Turn right when you have waited one minute.
- Turn right if it is safe to do so.

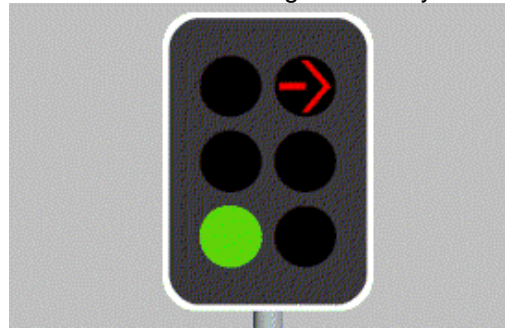

TL010 - Traffic Lights / Lanes

RUH

As you approach an intersection with traffic lights, the yellow light turns to red. You must -

- Stop and wait for the green light.
- Speed up to avoid traffic from the left and right.
- Sound your horn and proceed through the red light.

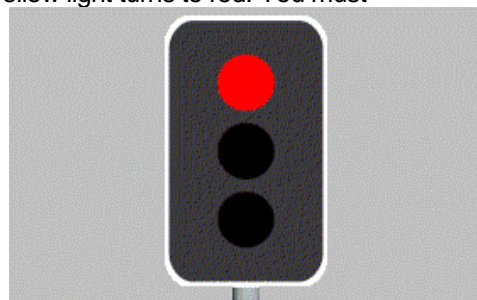

TL011 - Traffic Lights / Lanes

RUH

You approach an intersection showing a red light and the sign shown. You wish to turn left. You must -

- Stop and turn left only if it is safe.
- Stop and wait for a green light.
- Slow down and turn left if it is safe.



TRAFFIC SIGNS SECTION

SI001 – Traffic Signs

RUH

When you see this sign you should -

- Not drive beyond the sign.
- Drive with caution.
- Not pass another vehicle.



SI003 – Traffic Signs

RUH

What does this sign mean?

- All right lane traffic must turn right at the next intersection.
- Right lane traffic may turn right or go straight ahead at the next intersection.
- One way traffic ahead.



SI004 – Traffic Signs

RUH

What does this sign mean?

- Traffic travels in each direction.
- No turns permitted.
- Double lane bridge ahead.

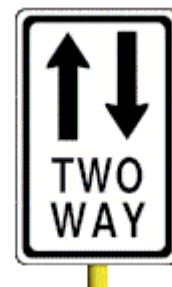

SI006 – Traffic Signs

RUH

What does this sign mean?

- You must not turn to the right.
- You may turn to the right.
- You must give way to traffic on your right.



SI007 – Traffic Signs
What does this sign mean?

RUH

- You must not turn to the left.
- You must not turn to the left or the right.
- You must not turn to the right.



SI008 – Traffic Signs
What does this sign mean?

RUH

- All traffic must travel in the direction of the arrow.
- Follow the arrow unless you are turning right.
- Road curves to the left ahead.



SI009 – Traffic Signs
What does this sign mean?

RUH

- You may travel only in the direction in which the arrow is pointing.
- No left turn.
- One lane bridge ahead, slow down.



SI013 – Traffic Signs
What does this sign mean?

RUH

- You are not to exceed 60 km/h.
- You can go faster than 60 km/h.
- You are on Highway 60.



SI014 – Traffic Signs
What does this sign mean?

RUH

- You must not drive faster than 100 km/h.
- You must drive faster than 100 km/h.
- The sign applies to truck drivers only, cars can travel at any speed.



SI016 – Traffic Signs
What does this sign mean?

RUH

- Drive carefully, and watch out for kangaroos entering the road for the next 30 km.
- Zoo 30 km ahead.
- Nature reserve 30 km ahead.



SI017 – Traffic Signs
What does this sign mean?

RUH

- T-intersection ahead. If you are on the terminating road, you must give way to all vehicles approaching from your right or left.
- No through road ahead, slow down.
- Tollway ahead, be prepared to stop and pay toll.



SI018 – Traffic Signs

RUH

When you see this sign you -

- Must not stop your vehicle at the kerb during the times shown.
- Must not stop here at any time.
- May stop at any time to pick up or drop off passengers.

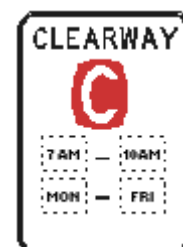

SI019 – Traffic Signs

RUH

You are most likely to find this sign -

- On the approach to a bridge which has room for only two vehicles, slow down and proceed with caution.
- When a bridge is not safe to drive on.
- If there is a footbridge for pedestrians ahead.



SI020 - Traffic Signs

RUH

What does this sign mean?

- Road may be slippery when wet, slow down and drive carefully.
- Sharp turns in the road ahead.
- Road under repair, drive carefully.



SI021 - Traffic Signs

RUH

You are most likely to find this sign -

- As you approach a winding road, slow down and drive with caution.
- If there is a steep hill ahead.
- If an unsealed road is ahead.



SI022 - Traffic Signs

RUH

What does this sign mean?

- A sharp depression in the road is ahead, be prepared, slow down.
- Do not drive with your lights on high beam.
- Police station ahead.



SI024 – Traffic Signs
What does this sign mean?

RUH

- Sharp bend to the right ahead, slow down and drive carefully.
- Turn around and go back, you are going the wrong way.
- No right turn allowed.



SI025 - Traffic Signs
You are most likely to find this sign, where -

RUH

- Children may be crossing the road ahead, slow down and be prepared to make a safe stop.
- There is an athletic field ahead.
- Pedestrians are not allowed.



SI026 - Traffic Signs
What does this sign mean?

RUH

- Crossroads ahead, reduce your speed and watch out for other traffic and pedestrians.
- Hospital ahead, drive carefully.
- Cemetery ahead.



SI027 – Traffic Signs

RUH

If the red lights on this sign are flashing what are you required to do?

- Stop until red lights stop flashing then drive on if it is safe to do so.
- Slow down and drive carefully over the crossing if you cannot see a train approaching.
- Stop until train has passed then proceed immediately.



SI028 – Traffic Signs

RUH

You should expect this sign, if -

- A give way sign at an intersection is ahead, slow down and be prepared to stop.
- You are approaching a school or playground.
- You are approaching an intersection with traffic lights, be prepared to stop.



SI029 - Traffic Signs

RUH

What does this sign mean?

- Narrow bridge ahead, room for only two vehicles, slow down and drive carefully.
- Two lane traffic ahead.
- One way traffic ahead do not overtake any other vehicles.



SI030 – Traffic Signs
What does this sign mean?

RUH

- Slow down and beware of trucks entering from the side.
- Trucks must use low gear.
- Heavy vehicle checking station ahead.



SI031 – Traffic Signs
What does this sign mean?

RUH

- Slow down and look out for pedestrians crossing the road ahead.
- Stop and help aged pedestrians across the road.
- Hospital ahead, slow down and proceed with caution.



SI032 – Traffic Signs
What does this sign mean?

RUH

- Pedestrian crossing ahead, slow down and be prepared to stop.
- Overhead footbridge for pedestrians ahead.
- Joggers ahead, drive carefully.



SI033 – Traffic Signs
You should expect this sign -

RUH

- When a divided road ends and two way traffic is ahead.
- If a one way street is ahead.
- If a one lane bridge is ahead.



SI035 – Traffic Signs
What does this sign mean?

RUH

- Workers ahead, slow down and be prepared to stop.
- Children's playground ahead, slow down and be prepared to stop.
- Do not litter.



SI036 - Traffic Signs
What does this sign mean?

RUH

- Watch out for bicycle riders along the roadway or when turning.
- Bicycle riders not allowed on the roadway.
- You are approaching a children's playground, slow down.



SI038 – Traffic Signs
What does this sign mean?

RUH

- If traffic lights are out of order or the amber light is flashing, you must stop and give way to traffic as if you are at an intersection with stop signs.
- Stop, red light camera in operation.
- Stop at all times and give way to all traffic.



SI039 - Traffic Signs
What does this sign mean?

RUH

- Stop sign ahead, slow down and prepare to stop.
- You are approaching a roundabout, prepare to give way.
- One way traffic ahead.



SI040 - Traffic Signs
What does this sign mean?

RUH

- Traffic controller ahead, slow down and be prepared to stop.
- School children crossing the road ahead, prepare to stop.
- Traffic lights out of order, Police on duty ahead.



SI041 – Traffic Signs
What does this sign mean?

RUH

- Steep down-grade in the road ahead, slow down.
- Road ahead slippery when wet, drive carefully.
- Road under repair, slow down.



SI042 - Traffic Signs
You should expect this sign, when -

RUH

- A divided road is ahead, prepare for a change in traffic conditions.
- A two lane bridge is ahead, slow down and drive carefully.
- Freeway conditions are ahead, maximum speed is 100 km/h.



SI043 – Traffic Signs
What does this sign mean?

RUH

- Railway level crossing with flashing signals ahead, slow down, drive carefully, and be prepared to stop.
- Intersection ahead with traffic lights, prepare to stop.
- Red light camera in use at traffic lights ahead.



SI045 – Traffic Signs

RUH

What does this sign mean?

- Road narrows ahead, slow down and prepare for a change in traffic conditions.
- Form one lane of traffic.
- Merging traffic, give way to your right.



SI046 – Traffic Signs

RUH

What does this sign mean?

- Vehicles are not allowed to stop at the kerb except in a medical emergency.
- Vehicles must not stop at the kerb, except if picking up a passenger.
- Vehicles must not stop at the kerb, unless picking up goods.



SI048 – Traffic Signs

RUH

What does this sign mean?

- Vehicles carrying three or more people, and motorcycles may use this lane.
- Motor cars carrying one passenger may use this lane.
- This lane is reserved for bicycle riders only.



SI049 - Traffic Signs

RUH

What does this sign mean?

- Railway level crossing ahead, slow down and look out for trains, be prepared to stop.
- Cattle or sheep crossing the road ahead, drive slowly.
- Give way sign ahead, slow down and be prepared to stop.



SI050 – Traffic Signs

RUH

When you see this sign, you should -

- Drive carefully and watch out for traffic entering from a side-road intersection ahead.
- Take care, trucks crossing the road ahead.
- Take a break, rest area ahead.



SI051 – Traffic Signs

RUH

When you see this sign you must -

- Stop at the stop line and give way to all traffic.
- Stop at the stop line and give way to all traffic on your right only.
- Slow down and be prepared to stop only if there is any danger of a collision with another vehicle or pedestrian.



SI052 - Traffic Signs

RUH

When you see this sign you must -

- Slow down and be prepared to stop and give way to all traffic if there is any danger of a collision.
- Stop and give way to all traffic even if the intersection is clear.
- Slow down and be prepared to give way to traffic on your right only, if there is any danger of a collision.



SI053 - Traffic Signs

RUH

When you see this sign you should -

- Come to a complete stop, look both ways for trains and proceed with caution if no trains are approaching.
- Slow down, then drive slowly over the crossing looking both ways for trains.
- Stop, only if a train is at the crossing.



SI056 - Traffic Signs

RUH

What does this sign mean?

- Slow down, the maximum safe speed around the next curve in the road is 35km/h.
- Winding road ahead for next 35 km.
- Next main town 35 km to the right.



SI057 - Traffic Signs

RUH

When you see this sign you should -

- Slow down and be prepared to stop if the lights start flashing, warning you of an approaching train.
- Continue at the same speed and not look both ways for approaching trains.
- Stop in the middle of the railway tracks and look both ways for approaching trains.



SI058 - Traffic Signs

RUH

What does this sign mean?

- You must stay in or move to the left lane, unless you are overtaking another vehicle.
- You must stay in the left lane and must not overtake any vehicles.
- You can overtake vehicles only on the left side.



SI059 - Traffic Signs

RUH

When you see this sign, what must you do?

- Slow down and be ready to stop and give way to a train.
- Stop before the railway crossing, wait for 1 minute and proceed if the crossing is clear.
- Drive quickly over the railway crossing.



SI060 - Traffic Signs

RUH

What does this sign mean?

- Slow down, be ready to stop and give way to all vehicles already on the roundabout if there is a danger of a collision.
- All traffic must turn back at the roundabout.
- Stop at all times and give way to all traffic on your right.



SI061 - Traffic Signs

RUH

When you see this sign you should -

- Drive carefully, you are reaching the top of the hill and will not be able to see a safe distance in front of you.
- Watch out, the road ahead may be flooded.
- Slow down, there is a dangerous curve ahead.



SI062 - Traffic Signs

RUH

What does this sign mean?

- There is a hump (sudden slope up and down) in the road ahead, slow down.
- There is a tunnel ahead, turn on your headlights.
- The road ahead is closed, go back.



SI063 - Traffic Signs

RUH

What does this sign tell you?-

- There may be animals on or near the road ahead, slow down and be prepared to stop to avoid collision.
- Animals are crossing the road ahead, stop and wait for directions.
- You are approaching an animal farm.

